



**SMARTSIDE®**  
TRIM & SIDING

## GENERAL

- Architectural Collection Vented Cut-To-Width (CTW) soffit provides a minimum ventilation of 10 in<sup>2</sup> per linear foot from the factory
- Choose Precision Series 38 Series or Foundations 76 Series soffit for closed soffit application. Precision Series 76 and 190 Series soffit for open soffit applications. Consult your local building code for guidance if it is necessary to rip the Precision Series 76 and 190 Series soffit in open soffit applications.
- Recommended spans for open and closed soffits are given in Table 1. The recommendations in Table 1 for open soffits also apply to combined roof/ceiling construction. Panels are assumed continuous over two or more spans with the long dimension or strength axis across supports for both applications.
- Precision Series 76 and 190 Series 4 ft. wide soffit is designed for open soffit applications (Figure 1) although it is suitable for closed soffit applications also (Figure 2). Precision Series 38 Series and Foundations 76 Series soffit can be used for closed soffit only (Figure 2).
- In open and closed soffit construction, protect panel edges against direct exposure to the weather with LP SmartSide trim and fascia. Apply LP SmartSide soffit in a manner that prevents moisture intrusion and water build-up. All openings, other than the vents, must be sealed, caulked, and/or flashed.
- SOFFITS MUST NOT BE IN DIRECT CONTACT WITH MASONRY, CONCRETE, BRICK, STONE, STUCCO OR MORTAR.

## FINISHING INSTRUCTIONS

### DO

- Priming all exposed wood substrates before painting is highly recommended.
- Paint all exposed soffit surfaces.
- Thoroughly paint the bottom edges of soffit especially all cut ends next to the roof line.
- Apply paint as soon as possible and within 180 days of application.
- Follow the coating manufacturer's application and maintenance instructions.
- High-quality acrylic latex paint, specially formulated for use on wood and engineered wood substrates, is highly recommended. Semi-gloss or satin finish oil or alkyd paints are acceptable. For flat alkyd paint, please check with the coating manufacturers for their recommendations for use on composite wood siding.

### Do Not Use:

- Semi-transparent stain.
- Shake and shingle paints.
- Vinyl-based resin formulas such as vinyl acetate, PVA, vinyl acetate/acrylic copolymer paints.

**HANDLE PREFINISHED LP SMARTSIDE PRODUCTS WITH EXTREME CARE DURING STORAGE AND APPLICATION. TOUCH UP ANY DAMAGE TO THE FINISH THAT MAY OCCUR DURING APPLICATION PER PREFINISHERS SPECIFICATIONS.**

## ARCHITECTURAL COLLECTION, PRECISION SERIES & FOUNDATIONS SOFFIT

## NAILING INSTRUCTIONS

TABLE 1

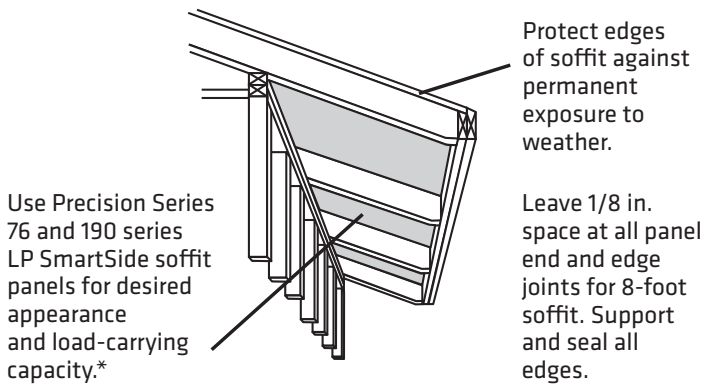
LP SmartSide CTW, Vented CTW and Soffit Panels (Long Dimension Across Supports)		
Maximum Span (inches) All Edges Supported	Nominal Panel Thickness	Nail Size and Type
24	Precision Series 38 Series LP SmartSide soffit	6d (0.099") nonstaining, hot-dipped galvanized box
24	Precision Series 76 and 190 Series LP SmartSide soffit	8d (0.113") nonstaining, hot-dipped galvanized box
24	Foundations 76 Series LP SmartSide soffit	8d (0.113") nonstaining, hot-dipped galvanized box

- Panels must be installed perpendicular to supports.
- Minimum size framing should be nominal 2 in. x 4 in.
- All panel edges must be supported or backed by solid framing.
- Consult your local building code for open soffit applications.
- Space nails 6 in. O.C. at panel edges and 12 in. O.C. at intermediate supports.
- **DO NOT USE STAPLES.**
- When installing the Architectural Collection vented soffit, avoid cutting through the vented areas. If it cannot be avoided, take special precautions to avoid damage to the spokes within the vent.
- Avoid diagonal cuts through the vented areas. If necessary all soffit edges must be supported or backed by solid framing. Use construction adhesive to attach spokes within the cut area of the vent to solid framing.
- Exhaust ducts shall terminate not less than 3 ft. in any direction from openings in vented soffit. Refer to your local code.
- The spokes within the vent may warp slightly during equilibration with the local environment. This condition is temporary and the spokes will straighten.
- Factory manufactured Cut-To-Width soffit is approved for use in closed soffit applications only.
- Field prepared Cut-To-Width soffit should comply with local building codes.
- Space and caulk the end and edge joints 1/8 in. when using 8-foot soffit.
- Space and caulk the end and edge joints 3/16 in. when using 16-foot soffit.
- **LP SmartSide Soffit products are not designed for and are not suitable for use as siding or trim other than Smooth Foundations Soffit.**
- For information on fastening LP SmartSide soffits in high wind speed areas, refer to APA Product Report PR-N117.

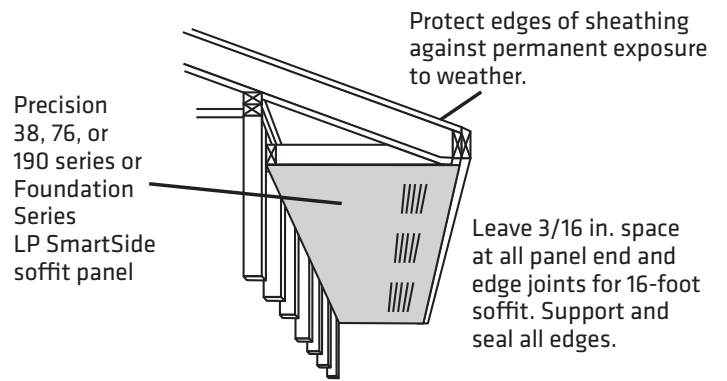
## GAPS & SEALANTS

- Seal all gaps with a high-quality, non-hardening, paintable sealant. Follow the sealant manufacturer's instructions for application.
- Use a high-quality exterior sealant meeting the ASTM C920, minimum Class 25 sealant.

**FIGURE 1: Open Soffit**

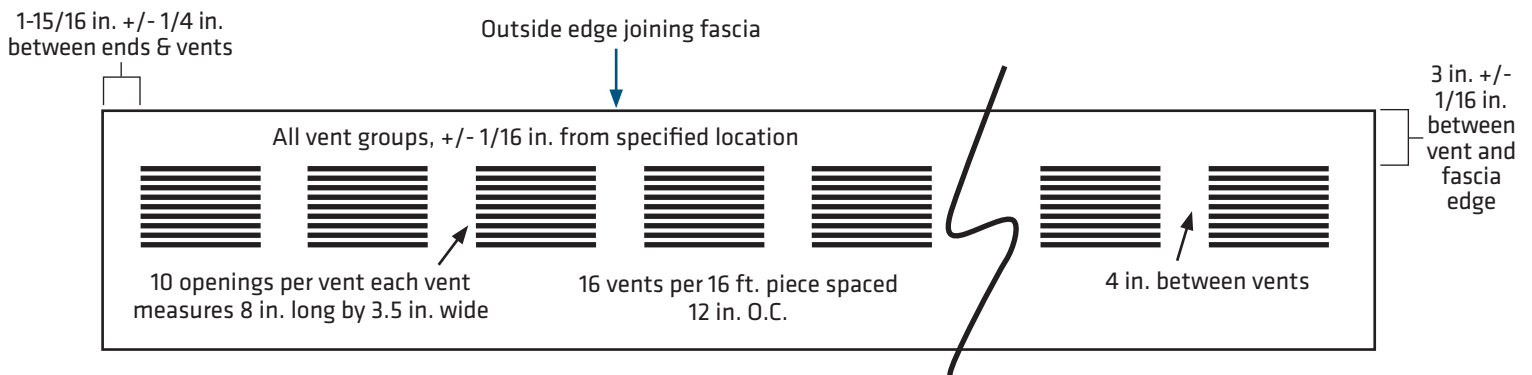


**FIGURE 2: Closed Soffit**

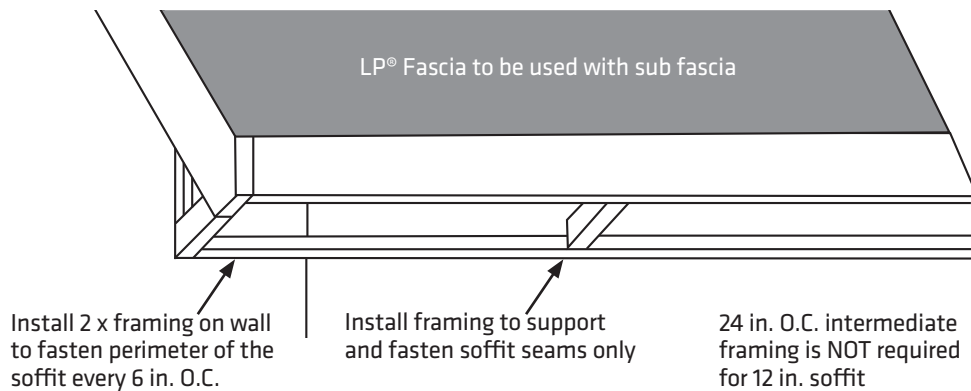


\*Do not use 76 Series Foundations Soffit in open soffit applications.

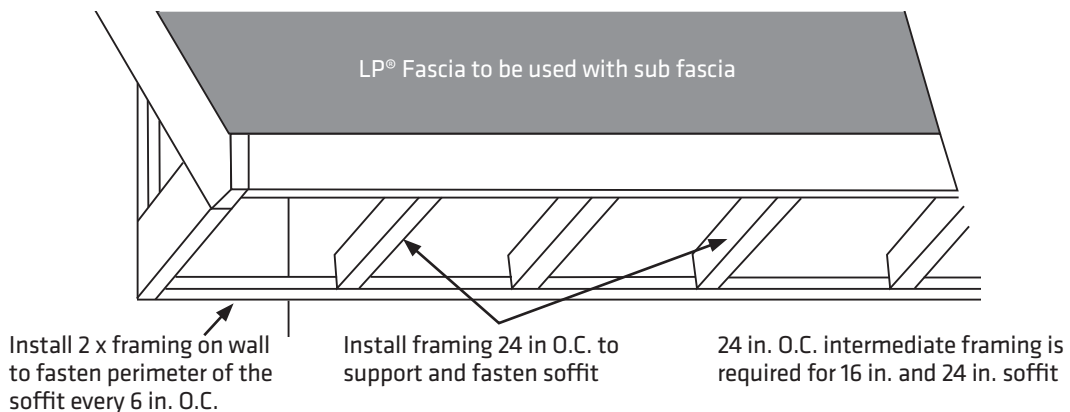
**FIGURE 3: Vented Soffit**



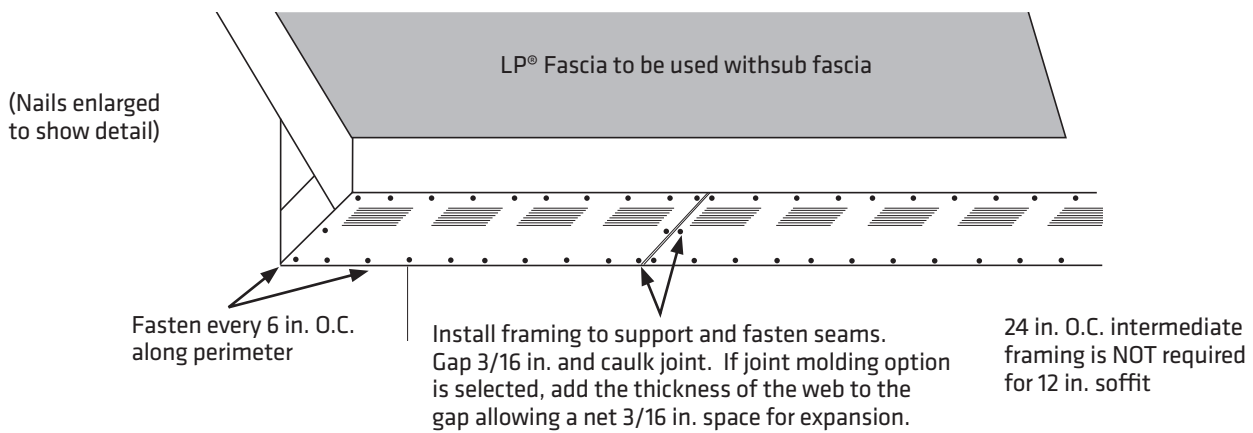
**FIGURE 4: 12 in. Cut to Width Soffit Framing Diagram**



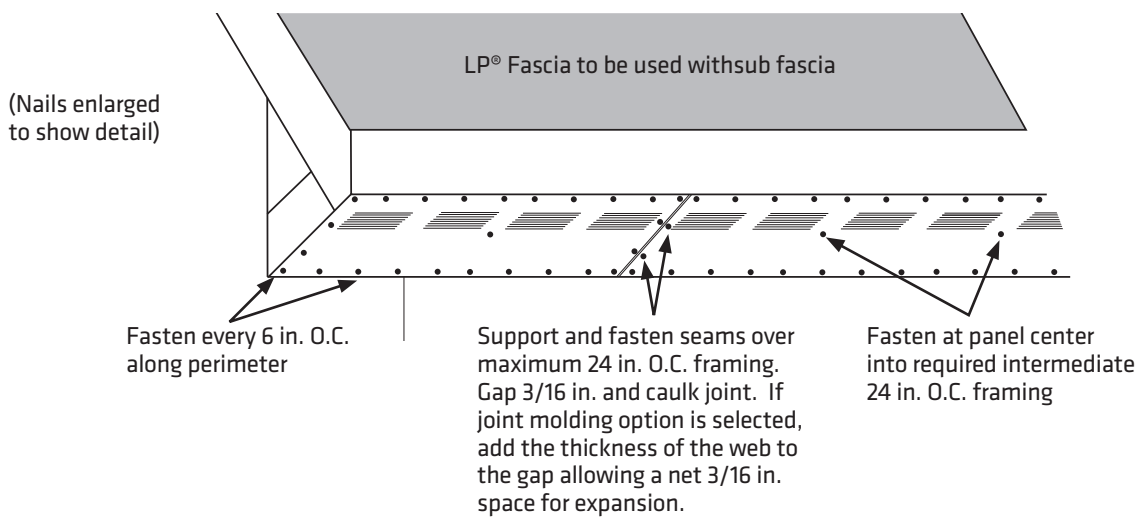
**FIGURE 5: 16 in. and 24 in. Cut to Width Soffit Framing Diagram**



**FIGURE 6: 12 in. Cut to Width Soffit Nailing Diagram**



**FIGURE 7: 16 in. & 24 in. Cut to Width Nailing Framing Diagram**



The Louisiana-Pacific Corporation (“LP”) LP SmartSide Soffit (the “Products”) limited warranty (the “Warranty”) applies only to structures on which the Products have been applied, finished and maintained in accordance with the published application, finishing and maintenance instructions in effect at the time of application. The failure to follow such application, finishing or maintenance instructions will void the Warranty as to the portion of the Products affected by the variance (the “Affected Products”).

LP assumes no liability for any loss or damage sustained by the Affected Products and is expressly released by the purchaser or owner from any such loss or liability.

Any modification of the Warranty’s application, finishing or maintenance requirements is void and unenforceable unless approved in writing prior to application by the Siding General Manager or his designee and a member of the LP Legal Department.

For a copy of the warranty or for installation and technical support, visit the LP SmartSide product support Web site at:

[www.lpsmartside.com](http://www.lpsmartside.com)

or for additional support call 800-450-6106.

**WARRANTY REMEDIES ARE NOT AVAILABLE IF REQUIREMENTS ARE NOT FOLLOWED.**

**Cal. Prop 65 Warning: Use of this product may result in exposure to wood dust, known to the State of California to cause cancer.**



©2014 Louisiana-Pacific Corporation. All rights reserved. LP and SmartSide are registered trademarks of Louisiana-Pacific Corporation. Printed in U.S.A.

NOTE: Louisiana-Pacific Corporation periodically updates and revises its product information. To verify that this version is current, call 800-450-6106.